

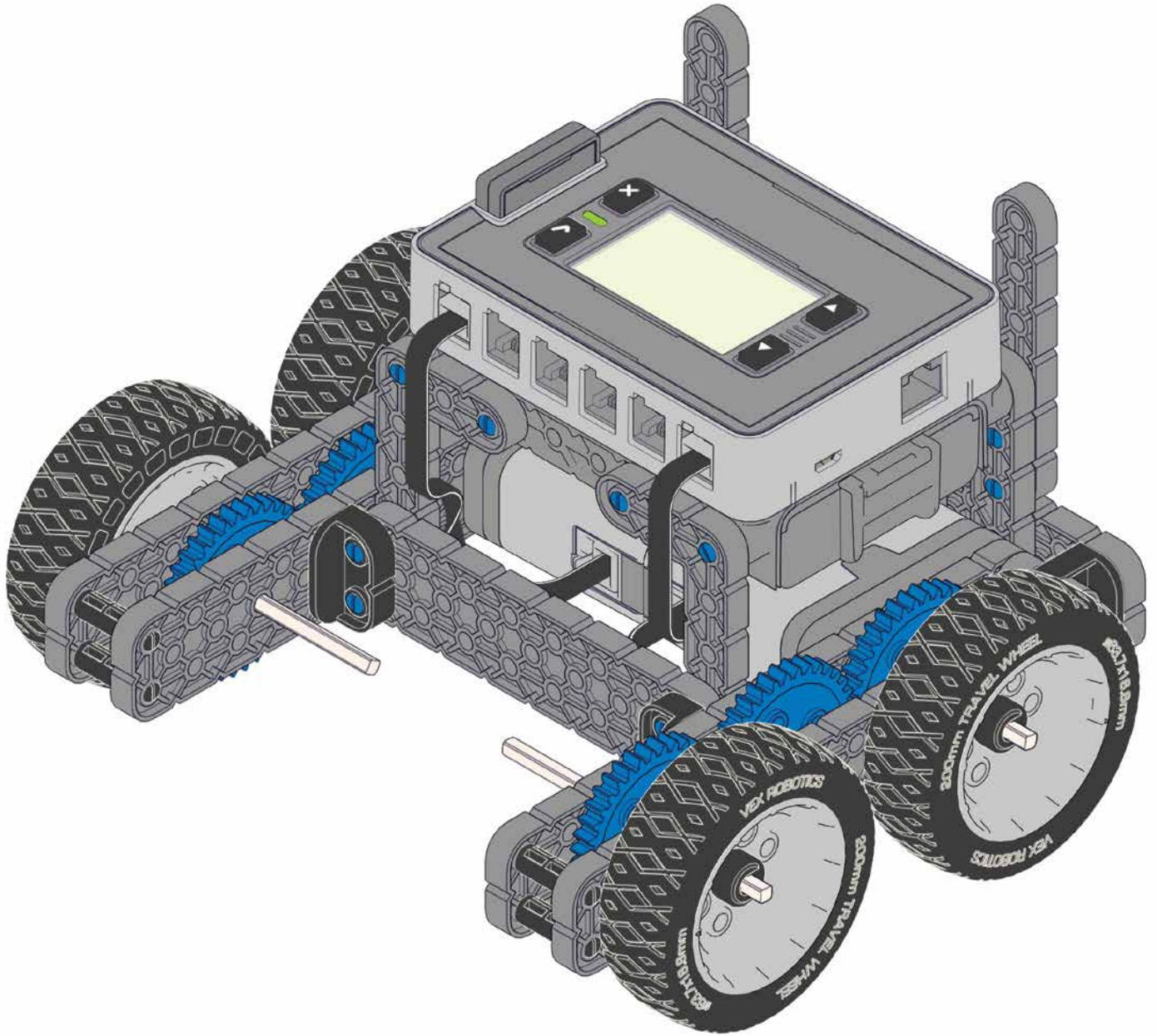

Your First Robot

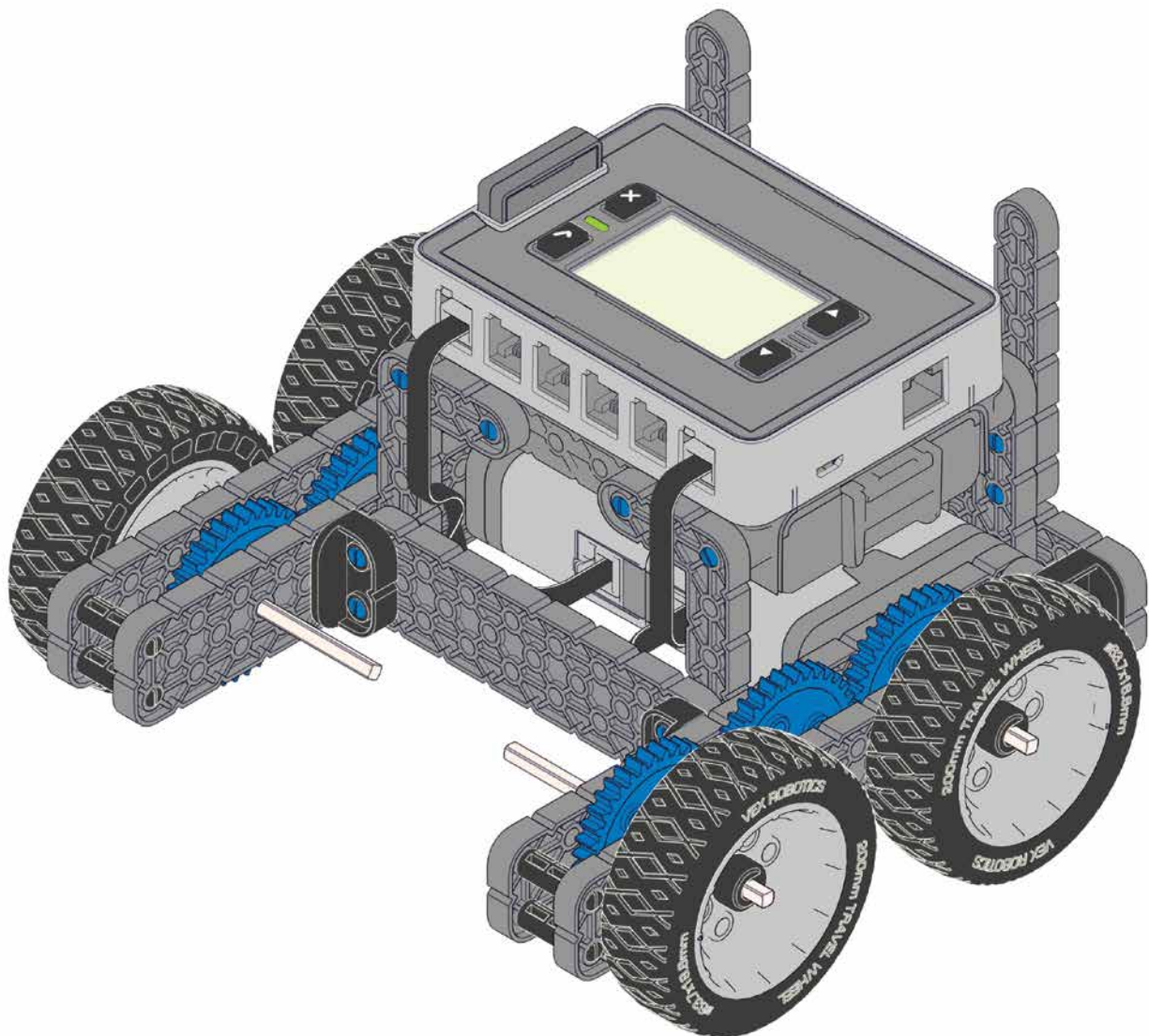



C.1

Your First Robot



Unit Overview:

In this unit you will build and test your first VEX IQ Robot. You will follow assembly instructions provided in your kit, and use the Your First Robot Build Rubric for evaluation. Idea Book Pages for each part of your build will be used to help you document your process and test your finished robot.

Unit Content:

- Your First Robot Build Options
- Learning Design Process

Unit Activities:

-  Robot build with assembly instructions (included with kit) and Your First Robot Build Rubric
-  Completion of Idea Book Pages with robot build and testing



Note: Separate copies and/or printouts of activities may be used for student work. Please see your teacher BEFORE writing in this guide. Visit www.vexiq.com/curriculum to download and print PDFs of all exercises!

C.2

Build and Test Clawbot IQ

There's nothing quite like building your first robot. The Clawbot IQ enables even a complete beginner to build and test a fully functional teleoperated robot! Just use the easy to follow VEX IQ Clawbot Assembly Instructions and you'll be on your way.

Build Options

Option 1: Follow the assembly instructions to complete and test the Standard Drive Base only. This gives you a fully functional drivetrain that can be operated and modified with your own creativity. Also note that this robot base will be the basis for other lessons as well, so your work will be used!

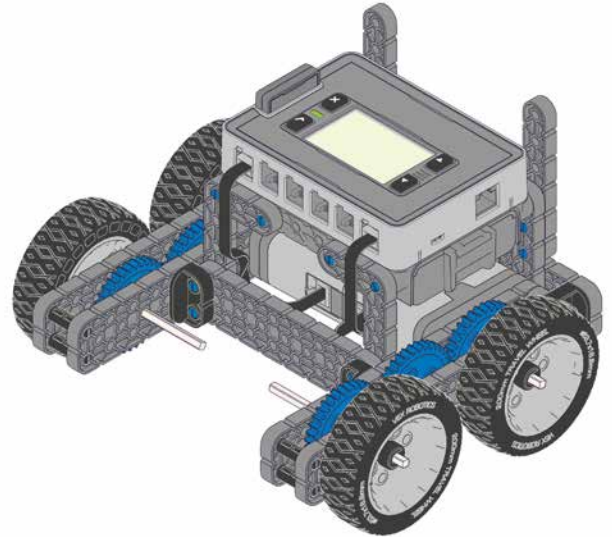

Option 2: Follow the assembly instructions to complete and test the Standard Drive Base then continue using the assembly instructions to build and complete the claw, tower, and object holder. Suggested test objects to use for full Clawbot IQ testing are VEX IQ Challenge game objects, tennis balls, cubes, or any similar object.

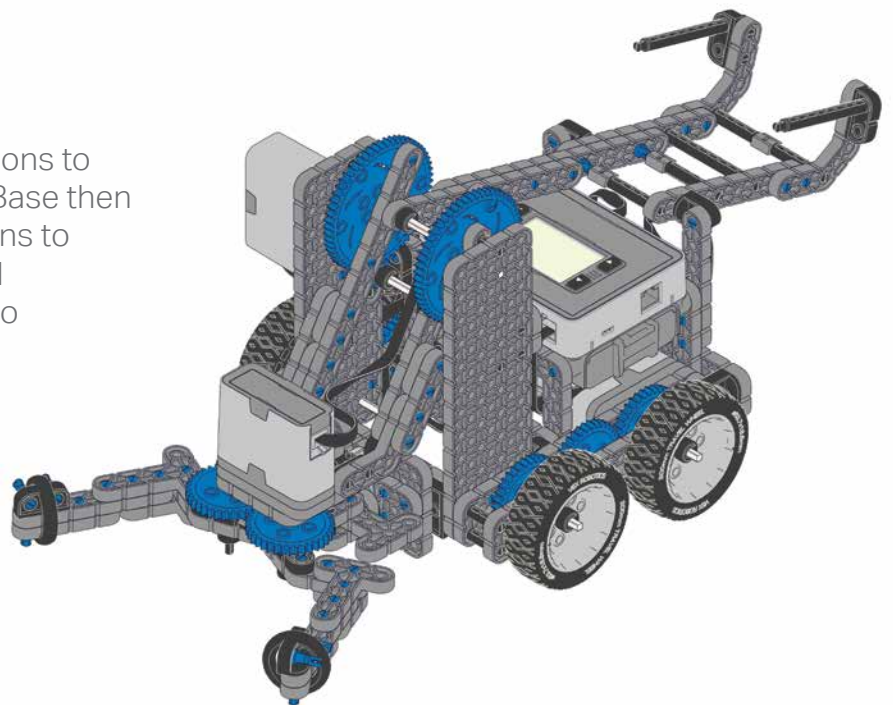

C.3

Downloadable Build Instructions

The Standard Drive Base and full Clawbot IQ build instructions can be downloaded online. Your teacher may have a copy already made for you; if not, visit www.vexiq.com/clawbot-iq to get started!

Your First Robot Idea Book Pages: Learning The Design Process

The Your First Robot unit also comes with Idea Book Pages that help guide you through your first robot build and help you to learn about the design process.

Engineering was defined in the It's Your Future unit as **using practical & scientific knowledge to create solutions for identified problems**. In that unit we also learned that engineers often use an engineering notebook to help them think about and solve problems. However, if questions and instructions aren't already on the page, what does an engineer write/draw in that notebook?

Engineers use a **design process** that is a series of steps that can be followed to help solve a problem and design a solution for something. This is similar to the "Scientific Method" that is taught to young scientists. There is no single universally accepted design process. Most engineers have their own twist for how the process works. The process is a cycle that generally starts with a problem and ends with a solution, but steps can vary.

When simplified, the design process can be seen as a three-step loop:

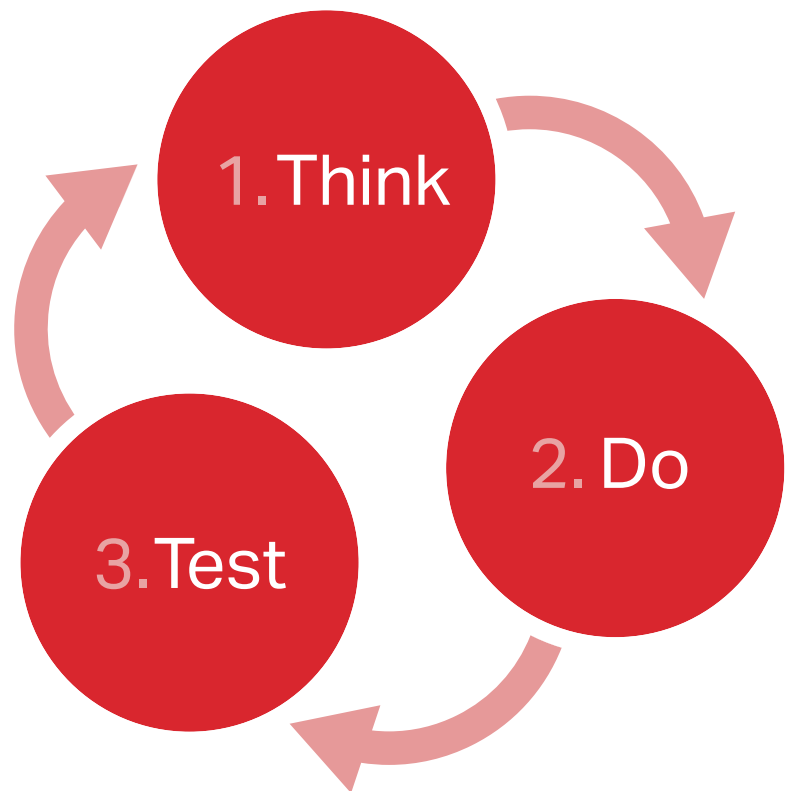

Step 1: Think about a problem or generate an idea. Don't forget to write it down and/or draw it. Sometimes the problem or idea is given to you, but sometimes you come up with the problem or idea on your own.

















Step 2: This is where you take action and "do" something to solve the problem or try to prove your idea. In our lessons, this is where you will build your potential solution.

Step 3: Test what you did in Step 2.

Is your problem fully solved? In testing, if you conclude the problem is not fully solved, then you have something more to think about. This means you write down or draw your next problem (that you see in testing) and repeat the cycle until your problem is fully solved. **Always keep in mind that problems ARE NOT failures. They are an expected part of the design process!**

In this unit you will use one Idea Book page for each "Think-Do-Test loop" you need to solve your given problem of following directions to build your first functional robot. The prompts and questions in the Idea Book Pages will lead you through the robot build, preparing you for full engineering notebook use when you make all of the design decisions in the future. **Now, build your first robot!**

Your First Robot: Build Rubric

Evaluation Criteria	Expert = 4	Proficient = 3	Emerging = 2	Novice = 1	Assessment	Comments
Design & Process Criteria						
Clawbot IQ Systems	Specified system(s) function(s) efficiently	Functioning specified system(s) exist(s)	Specified system(s) exist; partially function	Specified system(s) exist without function		
Design Process (documented in Idea Book as desired by teacher)	Design process utilized and documented creating enhanced efficiency	Design process utilized and fully documented	Design process utilized consistently	Some evidence that design process was utilized		
Utilization of Resources (materials and parts, Information and instructions, people, and time)	Resources used within constraints and efficiency maximized	Resources utilized to maximize efficiency	Evidence that some resources utilized meeting intended purpose	A few resources (e.g., materials and parts) utilized		
Technical Criteria						
Control System – Controller-Motor interaction	Completely functional control system with all expected system behaviors	Consistently functional control system with some expected system behaviors	Functional, but inconsistent control system behaviors	Non-functional or incomplete control system behaviors		
Electrical Systems	Battery charged. Wire routing safe, efficient, & completely functional	Battery charged. Wire routing safe & consistently functional	Functional, but Inconsistent (battery or wiring issues)	Non-functional or Incomplete (battery and wiring issues)		
Mechanical Systems (drivetrain, arm, claw)	Completely functional and consistent mechanical systems	Consistently functional mechanical systems	Functional, but inconsistent mechanical systems	Non-functional or incomplete/unsafe mechanical systems		
Unifying Themes (This area emphasizes the Interaction of Science, Technology, & Human Endeavor)						
Communication (written, electronic and/or oral as defined by the teacher)	Sophisticated and highly efficient communication for stated audiences	Purposeful, consistent, effective communication	Purposeful, partially consistent communication	Communication very inconsistent and lacks purpose		
Teamwork	Teamwork that maximizes outcomes is evident	Team members define roles, goals, & work together	Team members partially define roles, goals, & work together	Participants function separately within a group		

Your First Robot Idea Book Page: Standard Drive Base

Student Name(s): _____

Teacher/Class: _____ Date: _____ Page #: _____

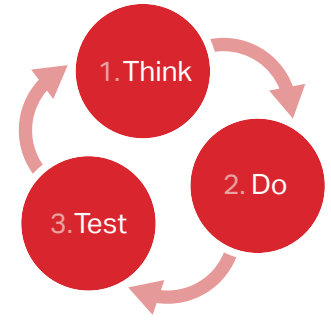

Instructions:

Follow the steps on this page while you use the Clawbot IQ Instructions (build steps 1-19) to build the Standard Drive Base.

1. "THINK" - Here is where your "idea" or "problem" is written/drawn:

Examples: "Idea - I want to build Clawbot's base" or "Problem - right side wheels don't turn."

Draw your idea or problem here, too, if it helps you to describe it.

2. "DO" - Here is where you list your task or tasks that your "THINK" step created:

Examples: "Use Clawbot IQ Instructions to build the Standard Drive Base" or "Check right side wheels, shaft, shaft collars, Smart Motor, and cable connection to Robot Brain."

3. "TEST" - After your "DO" step is done, test your design. Write down your observations:

Does your Standard Drive Base drive and function like is expected? YES NO

If you answered "YES" - Congratulations! You will score well on the Build Rubric. You may now move on to build the rest of the Clawbot IQ or move on to other lessons.

If you answered "NO" - Use your observations above and the Build Rubric to determine what problem exists, then use another copy of this page to help solve that problem. Keep repeating this "THINK-DO-TEST" process, until your Robot Base functions correctly.

Problems ARE NOT failures. They are an expected part of the design process!

Your First Robot Idea Book Page: Clawbot IQ Tower

Student Name(s): _____

Teacher/Class: _____ Date: _____ Page #: _____

Instructions:

Follow the steps on this page while you use the Clawbot IQ Instructions (build steps 20-38) to build the Clawbot IQ Tower (after Robot Base is done).

1. "THINK" - Here is where your "idea" or "problem" is written/drawn:
Examples: "Idea – I want to build Clawbot IQ's Tower." Or "Problem – Tower doesn't fit on the Standard Drive Base correctly."

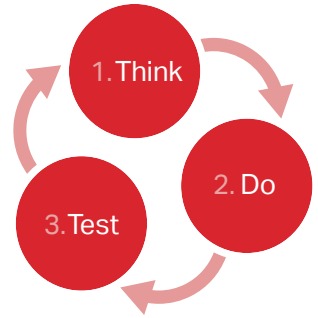

Draw your idea or problem here, too, if it helps you to describe it.

2. "DO" – Here is where you list your task or tasks that your "THINK" step created:
Examples: "Use Clawbot IQ Instructions to build Clawbot IQ Tower" or "Double check Tower assembly instructions for accuracy of my build."

3. "TEST" – After your "DO" step is done, test your design. Write down your observations:

Does your Clawbot IQ Tower function like is expected? YES NO

If you answered "YES" - Congratulations! You will score well on the Build Rubric. You may now move on to build the rest of Clawbot IQ or move on to other lessons.

If you answered "NO" - Use your observations above and the Build Rubric to determine what problem exists, then use another copy of this page to help solve that problem. Keep repeating this "THINK-DO-TEST" process, until your Tower functions correctly.

Problems ARE NOT failures. They are an expected part of the design process!

Your First Robot Idea Book Page: Clawbot IQ Object Holder

Student Name(s): _____

Teacher/Class: _____ Date: _____ Page #: _____

Instructions:

Follow the steps on this page while you use the Clawbot IQ Instructions (build steps 39-48) to build the Clawbot IQ Object Holder (after Base and Tower are done).

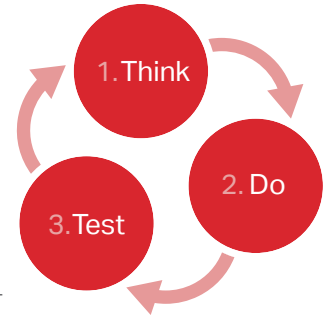

1. "THINK" - Here is where your "idea" or "problem" is written/drawn:
Examples: "Idea - I want to build the Clawbot IQ's Object Holder" or "Problem - Object Holder not correctly assembled."

Draw your idea or problem here, too, if it helps you to describe it.

2. "DO" – Here is where you list your task or tasks that your "THINK" step created:
Examples: "Use Clawbot Instructions to build Clawbot IQ Object Holder" or "Check Object Holder parts, compare to instructions, make necessary changes."

3. "TEST" – After your "DO" step is done, test your design. Write down your observations:

Does your Clawbot Object Holder function like is expected? YES NO

If you answered "YES" - Congratulations! You will score well on the Build Rubric. You may now move on to build the rest of Clawbot IQ or move on to other lessons.

If you answered "NO" - Use your observations above and the Build Rubric to determine what problem exists, then use another copy of this page to help solve that problem. Keep repeating this "THINK-DO-TEST" process, until your Object Holder functions correctly.

Problems ARE NOT failures. They are an expected part of the design process!

Your First Robot Idea Book Page: Clawbot IQ Claw

Student Name(s): _____

Teacher/Class: _____ Date: _____ Page #: _____

Instructions:

Follow the steps on this page while you use the Clawbot IQ Instructions (build steps 49-87) to build the Clawbot IQ Claw (after Robot Base, Tower, and Object Holder are done).

1. "THINK" - Here is where your "idea" or "problem" is written/drawn:
Examples: "Idea - I want to build the Clawbot IQ's Claw" or "Problem - Claw doesn't open or close."

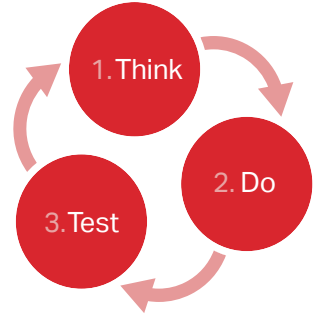

Draw your idea or problem here, too, if it helps you to describe it.

2. "DO" – Here is where you list your task or tasks that your "THINK" step created:
Examples: "Use Clawbot IQ Instructions to build Clawbot IQ Tower" or "Check claw motor, shaft, shaft collars, and cable connection to Robot Brain."

3. "TEST" – After your "DO" step is done, test your design. Write down your observations:

Does your Clawbot IQ Claw function like is expected? YES NO

If you answered "YES" - Congratulations! You will score well on the Build Rubric. You may now move on to other lessons.

If you answered "NO" - Use your observations above and the Build Rubric to determine what problem exists, then use another copy of this page to help solve that problem. Keep repeating this "THINK-DO-TEST" process, until your Claw functions correctly.

Problems ARE NOT failures. They are an expected part of the design process!